

## Surface Mount Transient Voltage Suppressor

### Uni-directional

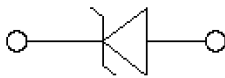

### Bi-directional

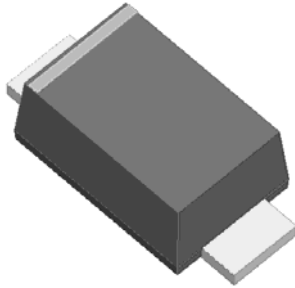
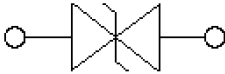
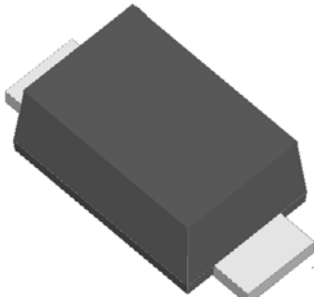

### Features

- For surface mounted applications
- Low-profile package
- Ideal for automated placement
- Available in Unidirectional and Bidirectional
- 200 W peak pulse power capability with a 10/1000  $\mu$ s waveform
- Low incremental surge resistance, excellent clamping capability
- Very fast response time: typically less than 1.0ns from 0 Volts to  $V_{BR}$  min
- High temperature soldering guaranteed: 260 °C/10 s at terminals
- Meets MSL level 1
- Component in accordance to RoHS

### Typical Applications

Use in sensitive electronics protection against voltage transients induced by inductive load switching and lighting on ICs, MOSFET, signal lines of sensor units for consumer, computer, industrial, telecommunication.

### Mechanical Date

- **Package:** SOD-123FL  
Molding compound meets UL 94 V-0 flammability rating, RoHS-compliant, halogen-free
- **Terminals:** Tin plated leads, solderable per J-STD-002 and JESD22-B102
- **Polarity:** For uni-directional types the band denotes cathode end, no marking on bi-directional types

### ■Maximum Ratings ( $T_a=25^\circ\text{C}$ Unless otherwise specified)

PARAMETER	SYMBOL	UNIT	Conditions	Max
Peak power dissipation <sup>(1)</sup> <sup>(2)</sup> (Fig.1)	$P_{PPM}$	W	with a 10/1000us waveform	200
Peak pulse current <sup>(1)</sup>	$I_{PPM}$	A	with a 10/1000us waveform	(See Next Table)
Power dissipation, on infinite heat sink	$P_D$	W	$T_L=75^\circ\text{C}$	0.4
Peak forward surge current, 8.3 ms single half sine-wave unidirectional only <sup>(3)</sup>	$I_{FSM}$	A		20
Operating junction and storage temperature range	$T_J, T_{STG}$	$^\circ\text{C}$		-55 to +150
Electrostatic Discharge	ESD	KV	IEC61000-4-2 air discharge	$\pm 30$
Electrostatic Discharge			IEC61000-4-2 contact discharge	
Thermal resistance <sup>(4)</sup>	$R_{\theta JL}$	$^\circ\text{C/W}$	Between junction and lead	40
	$R_{\theta JA}$		Between junction and Ambient	180



# SMF SERIES

Notes:

- (1). Non repetitive current pulse, per Fig2 and derated above  $T_A=25^{\circ}\text{C}$  per Fig3.
- (2).  $T_L=30^{\circ}\text{C}$  unless otherwise noted,  $V_F \leq 1.50\text{V}@1\text{A}$ .
- (3). Measured on 8.3 ms single half sine-wave or equivalent square wave, duty cycle = 4 pulses per minute maximum
- (4). Thermal resistance from junction to ambient and from junction to lead mounted on P.C.B. with 0.2" x 0.2" (5.0 mm x 5.0 mm) copper pad areas

## ■ Ordering Information (Example)

PREFERRED P/N	PACKING CODE	UNIT WEIGHT(g)	MINIMUM PACKAGE(pcs)	INNER BOX QUANTITY(pcs)	OUTER CARTON QUANTITY(pcs)	DELIVERY MODE
SMF SERIES	F1	0.0167	3000	30000	120000	7" reel
SMF SERIES	F2	0.0167	10000	20000	160000	13" reel

## ■ Electrical Characteristics ( $T_A=25^{\circ}\text{C}$ unless otherwise noted)

Part Number		Marking		Breakdown Voltage $V_{BR}@I_T$			Maximum Reverse Leakage $I_R^{(3)}$ @ $V_{RWM}$ ( $\mu\text{A}$ )	Working Peak Reverse Voltage $V_{RWM}$ (V)	Maximum Reverse Surge Current $I_{PP}^{(2)}$ (A)	Maximum Clamping Voltage $V_C$ @ $I_{PP}$ (V)
(Uni)	(Bi)	(Uni)	(Bi)	Min(V)	Max (V)	$I_T^{(1)}$ (mA)				
SMF5.0A	SMF5.0CA	5.0A	5.0CA	6.40	7.07	10	400.0	5.0	21.74	9.2
SMF6.0A	SMF6.0CA	6.0A	6.0CA	6.67	7.37	10	400.0	6.0	19.42	10.3
SMF6.5A	SMF6.5CA	6.5A	6.5CA	7.22	7.98	10	250.0	6.5	17.86	11.2
SMF7.0A	SMF7.0CA	7.0A	7.0CA	7.78	8.60	10	100.0	7.0	16.67	12.0
SMF7.5A	SMF7.5CA	7.5A	7.5CA	8.33	9.21	1	50.0	7.5	15.50	12.9
SMF8.0A	SMF8.0CA	8.0A	8.0CA	8.89	9.83	1	25.0	8.0	14.71	13.6
SMF8.5A	SMF8.5CA	8.5A	8.5CA	9.44	10.40	1	10.0	8.5	13.89	14.4
SMF9.0A	SMF9.0CA	9.0A	9.0CA	10.00	11.10	1	5.0	9.0	12.99	15.4
SMF10A	SMF10CA	10A	10CA	11.10	12.30	1	2.5	10.0	11.76	17.0
SMF11A	SMF11CA	11A	11CA	12.20	13.50	1	2.5	11.0	10.99	18.2
SMF12A	SMF12CA	12A	12CA	13.30	14.70	1	2.5	12.0	10.05	19.9
SMF13A	SMF13CA	13A	13CA	14.40	15.90	1	1.0	13.0	9.30	21.5
SMF14A	SMF14CA	14A	14CA	15.60	17.20	1	1.0	14.0	8.62	23.2
SMF15A	SMF15CA	15A	15CA	16.70	18.50	1	1.0	15.0	8.20	24.4
SMF16A	SMF16CA	16A	16CA	17.80	19.70	1	1.0	16.0	7.69	26.0
SMF17A	SMF17CA	17A	17CA	18.90	20.90	1	1.0	17.0	7.25	27.6
SMF18A	SMF18CA	18A	18CA	20.00	22.10	1	1.0	18.0	6.85	29.2
SMF19A	SMF19CA	19A	19CA	21.10	23.30	1	1.0	19.0	6.54	30.6
SMF20A	SMF20CA	20A	20CA	22.20	24.50	1	1.0	20.0	6.17	32.4
SMF22A	SMF22CA	22A	22CA	24.40	26.90	1	1.0	22.0	5.63	35.5
SMF24A	SMF24CA	24A	24CA	26.70	29.50	1	1.0	24.0	5.14	38.9
SMF26A	SMF26CA	26A	26CA	28.90	31.90	1	1.0	26.0	4.75	42.1
SMF28A	SMF28CA	28A	28CA	31.10	34.40	1	1.0	28.0	4.41	45.4
SMF30A	SMF30CA	30A	30CA	33.30	36.80	1	1.0	30.0	4.13	48.4
SMF33A	SMF33CA	33A	33CA	36.70	40.60	1	1.0	33.0	3.75	53.3
SMF36A	SMF36CA	36A	36CA	40.00	44.20	1	1.0	36.0	3.44	58.1
SMF40A	SMF40CA	40A	40CA	44.40	49.10	1	1.0	40.0	3.10	64.5
SMF43A	SMF43CA	43A	43CA	47.80	52.80	1	1.0	43.0	2.88	69.4
SMF45A	SMF45CA	45A	45CA	50.00	55.30	1	1.0	45.0	2.75	72.7
SMF48A	SMF48CA	48A	48CA	53.30	58.90	1	1.0	48.0	2.58	77.4
SMF51A	SMF51CA	51A	51CA	56.70	62.70	1	1.0	51.0	2.43	82.4
SMF54A	SMF54CA	54A	54CA	60.00	66.30	1	1.0	54.0	2.30	87.1



# SMF SERIES

Part Number		Marking		Breakdown Voltage $V_{BR}@I_T$			Maximum Reverse Leakage $I_R^{(3)}$ @ $V_{RWM}$ ( $\mu A$ )	Working Peak Reverse Voltage $V_{RWM}$ (V)	Maximum Reverse Surge Current $I_{PP}^{(2)}$ (A)	Maximum Clamping Voltage $V_c$ @ $I_{PP}$ (V)
(Uni)	(Bi)	(Uni)	(Bi)	Min(V)	Max (V)	$I_T^{(1)}$ (mA)				
SMF58A	SMF58CA	58A	58CA	64.40	71.20	1	1.0	58.0	2.14	93.6
SMF60A	SMF60CA	60A	60CA	66.70	73.70	1	1.0	60.0	2.07	96.8
SMF64A	SMF64CA	64A	64CA	71.10	78.60	1	1.0	64.0	1.94	103.0
SMF70A	SMF70CA	70A	70CA	77.80	86.00	1	1.0	70.0	1.77	113.0
SMF75A	SMF75CA	75A	75CA	83.30	92.10	1	1.0	75.0	1.65	121.0
SMF78A	SMF78CA	78A	78CA	86.70	95.80	1	1.0	78.0	1.59	126.0
SMF80A	SMF80CA	80A	80CA	88.80	97.60	1	1.0	80.0	1.55	129.0
SMF85A	SMF85CA	85A	85CA	94.40	104.00	1	1.0	85.0	1.46	137.0
SMF90A	SMF90CA	90A	90CA	100.00	111.00	1	1.0	90.0	1.37	146.0
SMF100A	SMF100CA	100A	100CA	111.00	123.00	1	1.0	100.0	1.23	162.0
SMF110A	SMF110CA	110A	110CA	122.00	135.00	1	1.0	110.0	1.13	177.0
SMF120A	SMF120CA	120A	120CA	133.00	147.00	1	1.0	120.0	1.04	193.0
SMF130A	SMF130CA	130A	130CA	144.00	159.00	1	1.0	130.0	0.96	209.0
SMF140A	SMF140CA	140A	140CA	155.00	171.00	1	1.0	140.0	0.89	224.0
SMF150A	SMF150CA	150A	150CA	167.00	185.00	1	1.0	150.0	0.82	243.0
SMF160A	SMF160CA	160A	160CA	178.00	197.00	1	1.0	160.0	0.77	259.0
SMF170A	SMF170CA	170A	170CA	189.00	209.00	1	1.0	170.0	0.73	275.0
SMF180A	SMF180CA	180A	180CA	200.00	220.00	1	1.0	180.0	0.68	292.0
SMF190A	SMF190CA	190A	190CA	211.00	232.00	1	1.0	190.0	0.65	308.0
SMF200A	SMF200CA	200A	200CA	224.00	247.00	1	1.0	200.0	0.62	324.0
SMF220A	SMF220CA	220A	220CA	246.00	272.00	1	1.0	220.0	0.56	356.0

Notes:

- (1)  $t_p \leq 50ms$  Pulse test:  $t_p \leq 50ms$ .
- (2) Surge current waveform per Fig. 2 and derated per Fig.3.
- (3) For bi-directional types having  $V_{RWM}$  of 10 V and less, the  $I_R$  limit is doubled.

## ■ Characteristics(Typical)

FIG1: Peak Pulse Power Rating Curve

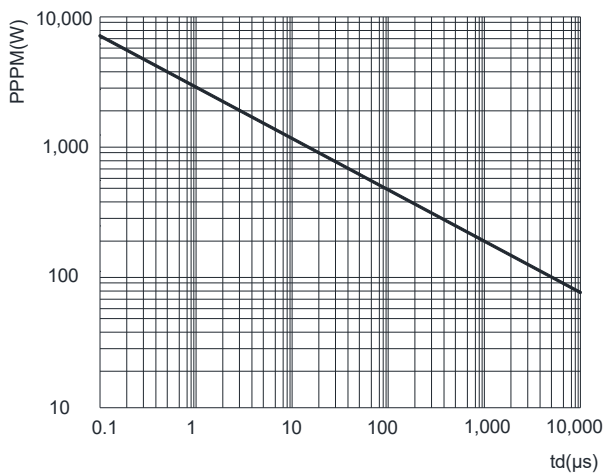
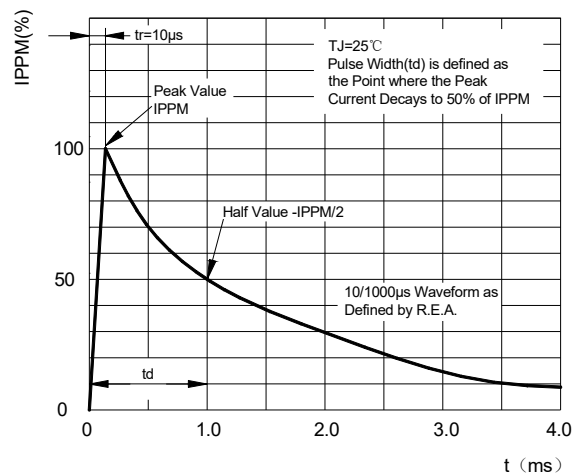

FIG2: Pulse Waveform





# SMF SERIES

## ■ Characteristics(Typical)

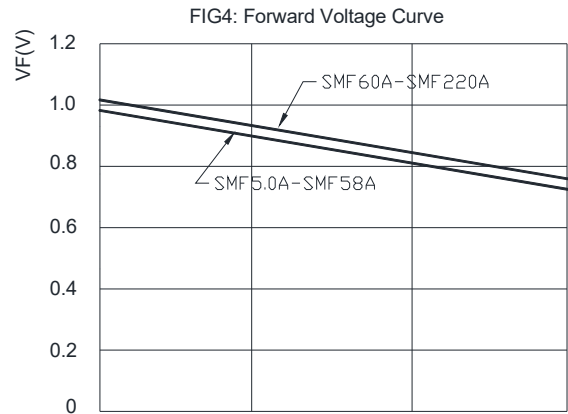
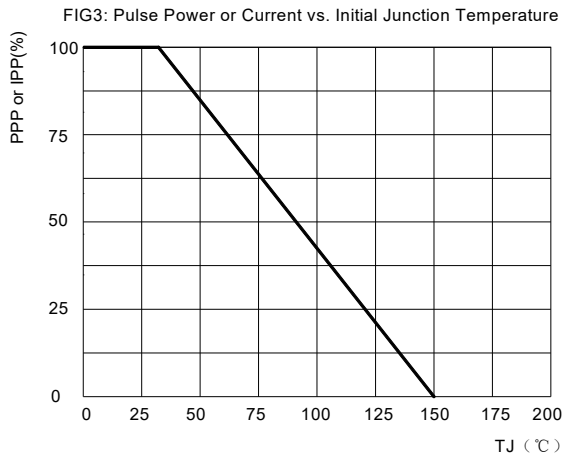

## ■ Outline Dimensions

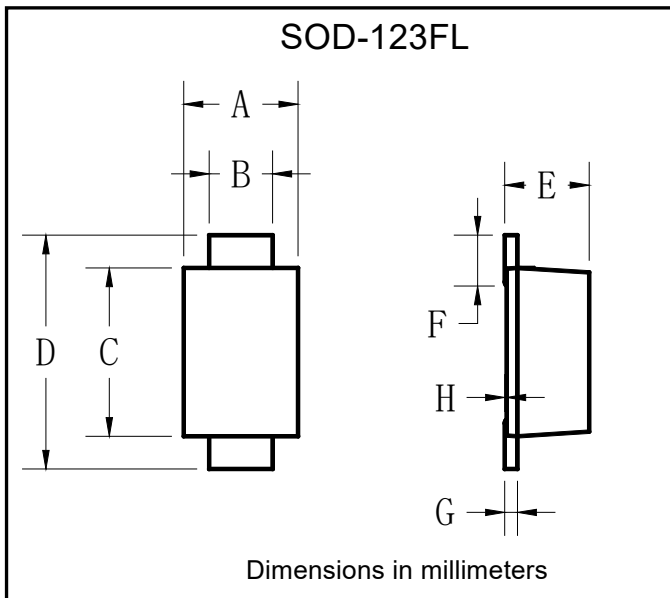

SOD-123FL		
Dim	Min	Max
A	1.60	1.90
B	0.90	1.10
C	2.55	2.85
D	3.60	3.90
E	1.00	1.20
F	0.40	0.90
G	0.10	0.25
H	0.02	0.05

## ■ Suggested pad layout

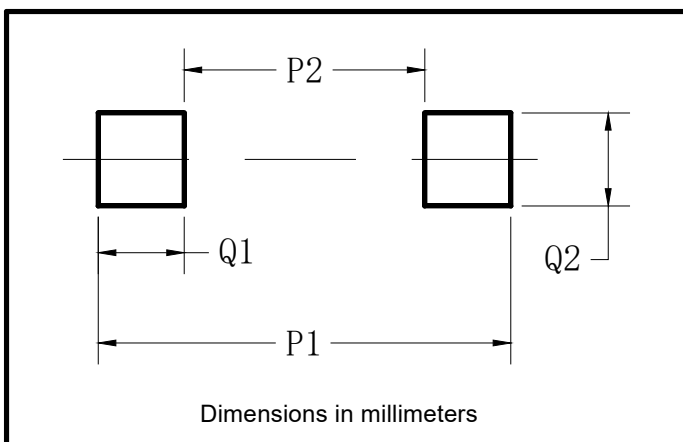

SOD-123FL	
Dim	Millimeters
P1	3.90
P2	1.90
Q1	1.00
Q2	1.50



## SMF SERIES

---

### Disclaimer

The information presented in this document is for reference only. Yangzhou Yangjie Electronic Technology Co., Ltd. reserves the right to make changes without notice for the specification of the products displayed herein to improve reliability, function or design or otherwise.

The product listed herein is designed to be used with ordinary electronic equipment or devices, and not designed to be used with equipment or devices which require high level of reliability and the malfunction of which would directly endanger human life (such as medical instruments, transportation equipment, aerospace machinery, nuclear-reactor controllers, fuel controllers and other safety devices), Yangjie or anyone on its behalf, assumes no responsibility or liability for any damages resulting from such improper use of sale.

This publication supersedes & replaces all information previously supplied. For additional information, please visit our website [http:// www.21yangjie.com](http://www.21yangjie.com) , or consult your nearest Yangjie's sales office for further assistance.